



AndAPT

PROGRAMMABLE POWER

Supplying next generation scalable power

programmable analog, digital, and power:
everything you need in a single chip

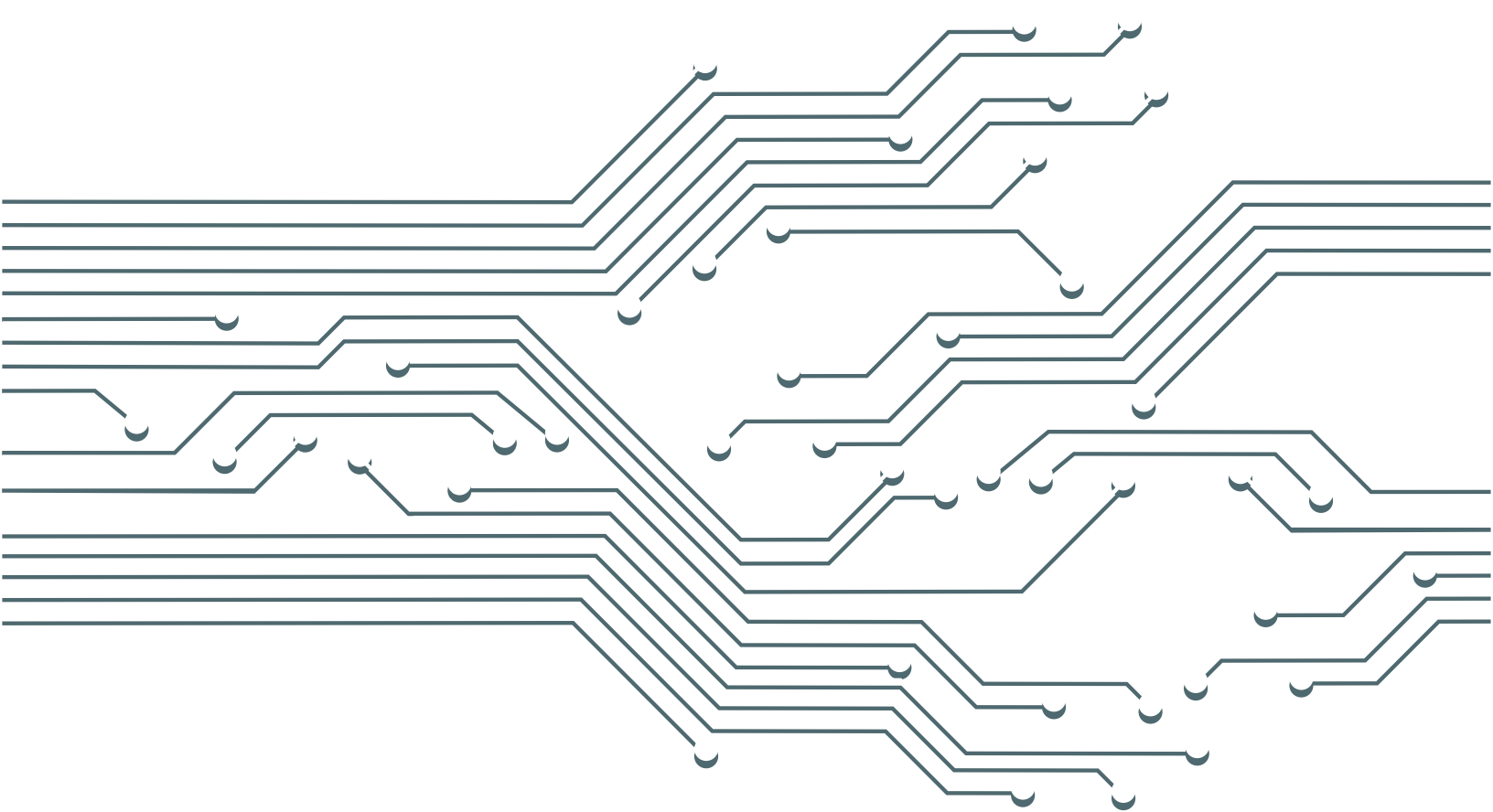

AmP chips deliver unparalleled integration, superior performance, and quickest time-to-market while reducing system costs

The constantly evolving and widespread use of FPGAs, SoCs across industries has transformed how these systems are powered. Frequently, it takes an entire village to bring such a system up; a village consisting of analog elements, digital logic, and various power chips for different needs, all coming together. Often the myriad power rails requirements can add upwards of 20 unique chips for one system.

The time is ripe for a transformation in how we power our systems.

closing the gap

AnDAPT was founded with the vision to address the market gap for simplifying powering SoCs and FPGAs while delivering superior system power performance at reduced costs.

AmP chips are based on industry's first adaptive analog technology combining digital programming fabric with analog components, and power elements in one programmable chip.

This enables creating multitude of power solutions integrating up to 10 unique power rails anywhere from mA to 70 A, along with mixed-signal logic in one chip within minutes.

a new platform: analog, digital, power - programmable



why analog, digital, and power make for an awesome mix?

The problems we are solving are born out of diverse needs of powering devices and our solution embodies this diversity.

Analog proficiency ensures-

- high efficiency
- analog switching speeds
- loss-less current sense for current mode and current share
- sophisticated single/multi-phase point of loads

Digital flexibility affords-

- ease of solution scaling: one chip programs into over 300+ combinations
- optimize and tune as per need: performance/efficiency/cost/space
- telemetry: performance monitoring
- integrate dissimilar power components

Analog components are interconnected on digital fabric to create fully functional analog power components with custom designs created within minutes

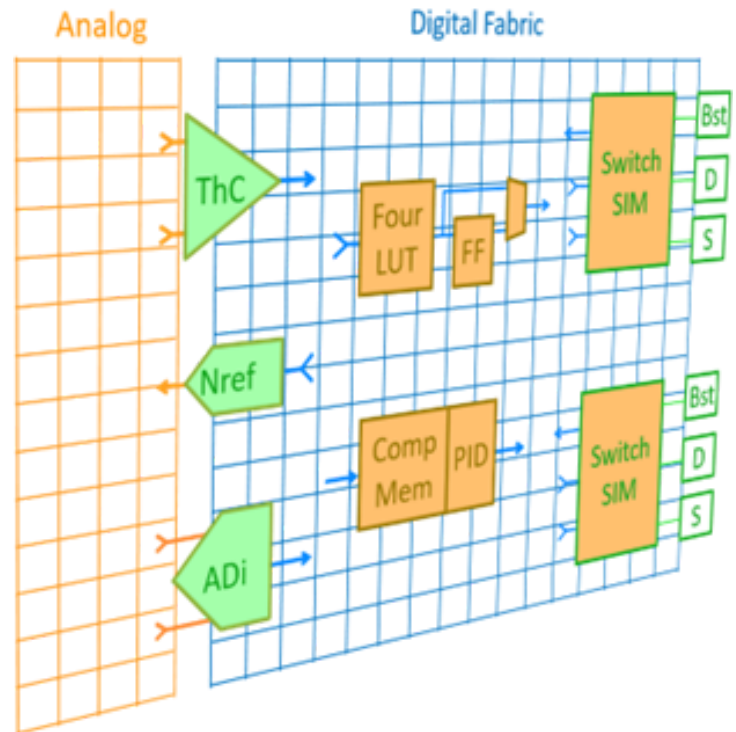

μAnalog with digital wrappers on interconnect fabric

available power components

Library of power components include-

- voltage regulators/switchers: buck, boost (synchronous/asynchronous)
- linears: LDOs, load switches
- vtt terminator
- multi-phase DrMOS controllers
- sequencer
- telemetry
- reset generator
- comparators
- source selector
- zoom controller
- logic gates etc.

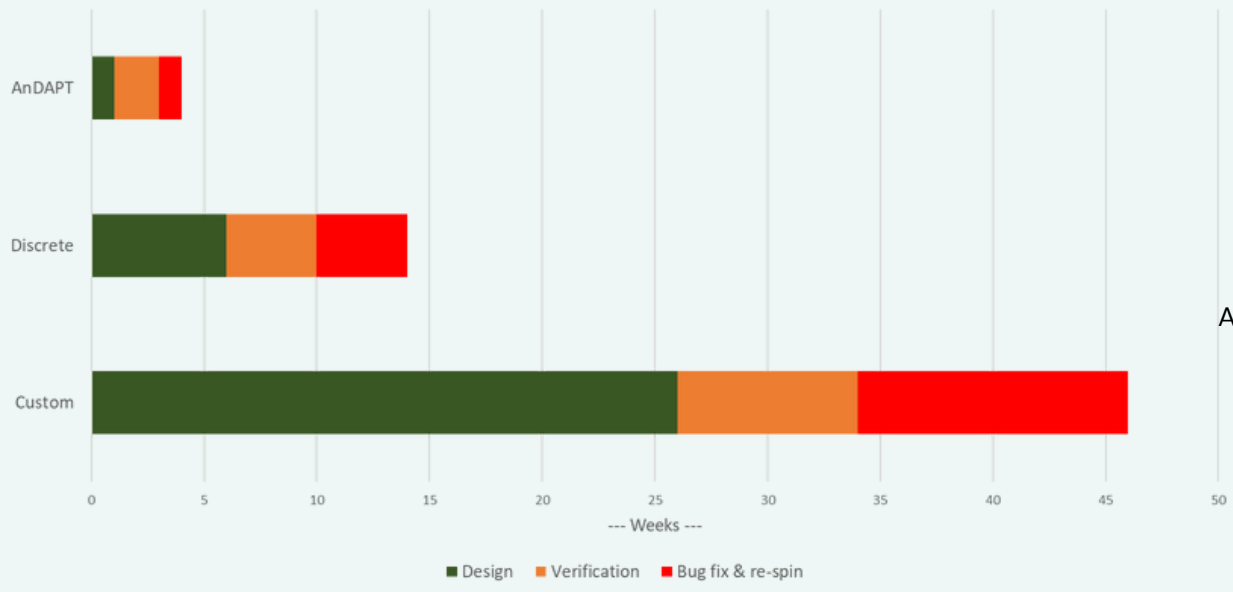

- traditional methods take a long time
- re-spins often cause missed product launches

AnDAPT approach-

- move hardware into software saving time
- subsequent designs even faster

power management design times

custom power within minutes

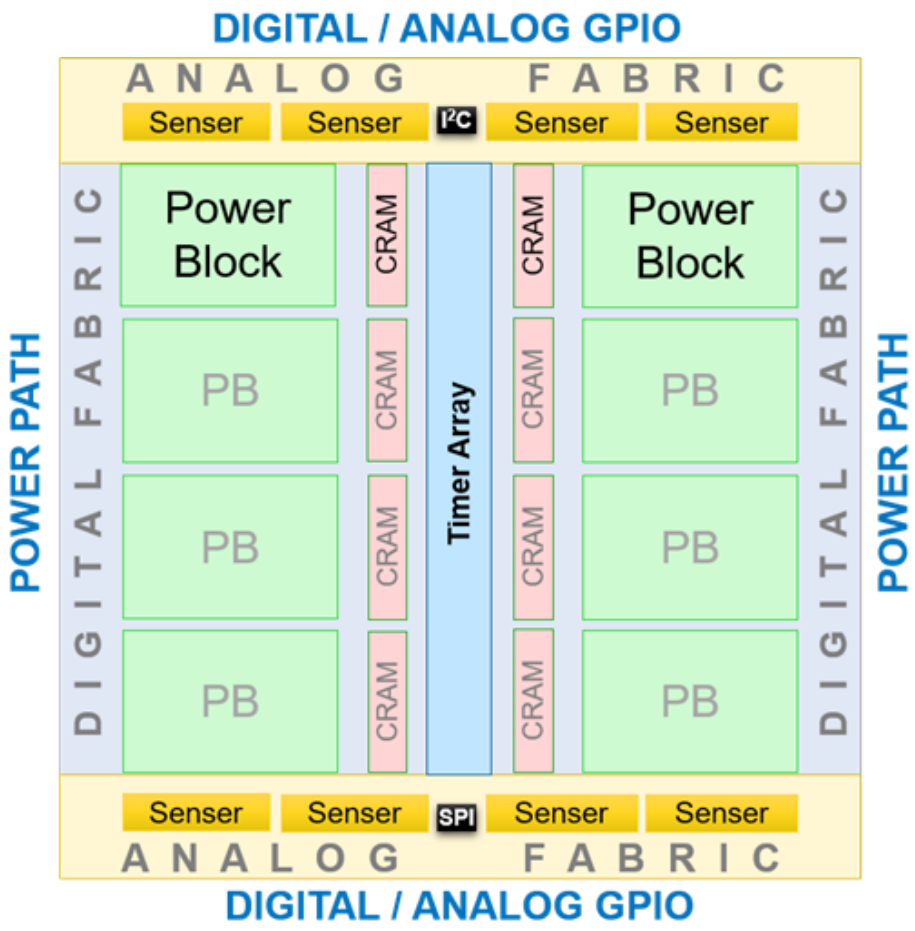

AnDAPT's multi-rail power platform, AmP delivers industry's first on-demand power management solution for a wide range of applications including:

- industrial networking
- enterprise storage
- ip security cameras
- video/image processing
- industrial/medical
- computing: AI/ML systems
- wireless base station

Key features include:

- **integrated power blocks** to build a variety of integrated MOSFET regulator topologies and switches
- **integrated sensor blocks** to monitor current, voltage, and temperature for telemetry, warning, and protection
- **digital and analog fabric** to connect power blocks and sensor blocks for sensing, control loop, telemetry, and sequencing

AmP- μAnalog elements

The AnDAPT AmP architecture includes three primary functional groups. Each element is connected via shielded internal wiring for noise isolation.

power blocks

each AmP device contains eight scalable MOSFET (SIM) elements. Depending on the design, SIMs are either independent or in pairs. Paired SIMs share inputs and employ fewer package pins.

Each SIM element supports six Amps. The MOSFETS are scalable and segmented with low RDS(on) resistance for built-in current-mode operation and for current balancing.

Each SIM element supports both linear mode and switched-mode operation.

sensor blocks

the sensor blocks provide capabilities to measure voltage and current levels. A sensor block includes:

- three noise-immune voltage references
- four threshold comparators
- a summation amplifier
- an adaptive error digitizer

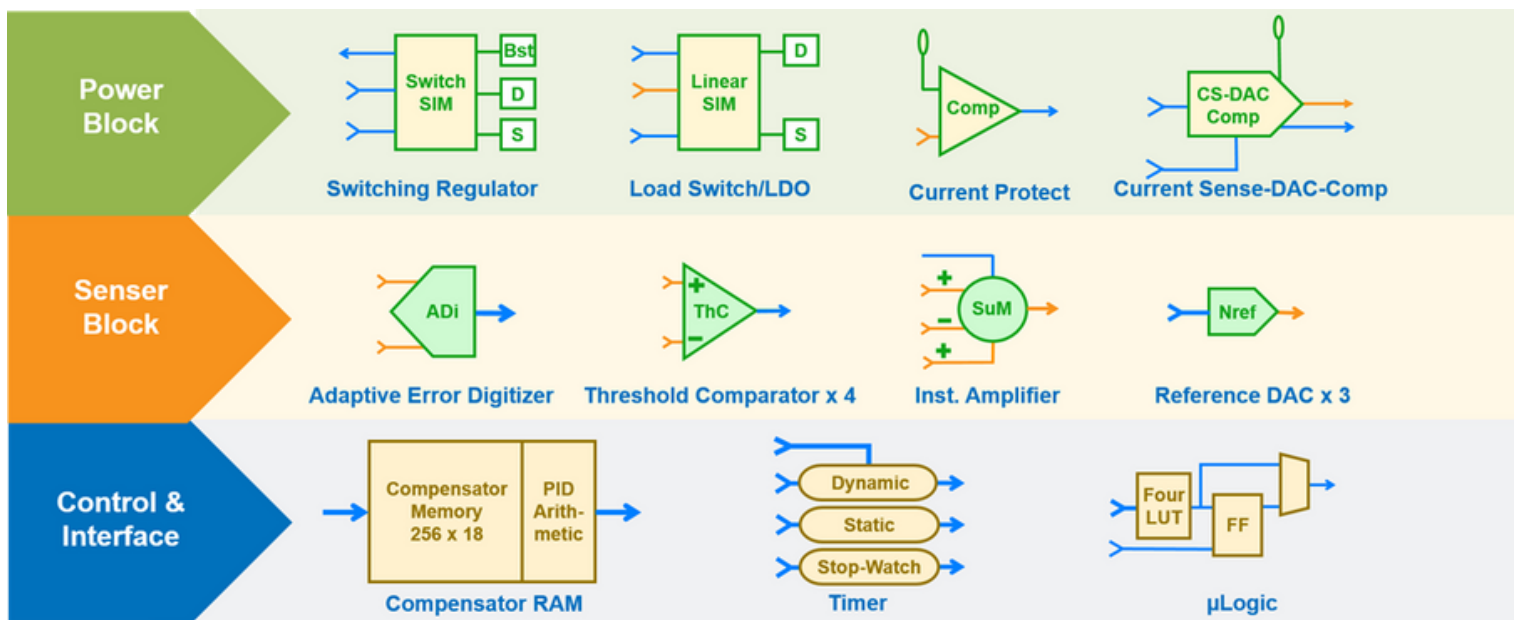



smallest BoM area:
AmP saves avg 17%
area compared to
discrete solutions



scalable solution:
component library
allows dynamic
system evolution



one part:
order **only One**
part. Inventory
simplified

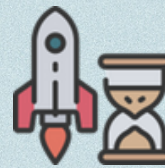

Quick time-to-
market:
Proven designs,
reduced cost

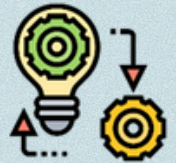

modify design:
revise power/
analog/digital
requirements quickly

digital fabric control and interface

each AmP device includes a digital fabric for building control loops, sequencers, or interfaces between functions or other components on the board. The analog elements in the power blocks and sensor blocks have a digital interface which connects to other elements within the AmP device. The AmP's digital fabric includes functions to monitor and control the analog features and to provide connections to the remainder of the system including the following elements.

- compensator RAMs with PID arithmetic (CR)
- precision modulation timer (PMT)
- programmable blocks
- analog and digital general purpose I/O (GPIO)
- eight clock distribution networks
- two on-chip oscillators with selectable frequency and clock phases

building power components

by seamlessly combining analog power functions with flexible, digital control and telemetry, an AmP device affordably integrates multiple, heterogeneous power rails with different regulator topologies and regulation methods.

- compensator RAMs with PID arithmetic (CR)
- precision modulation timer (PMT)
- programmable blocks
- analog and digital general purpose I/O (GPIO)
- eight clock distribution networks
- two on-chip oscillators with selectable frequency and clock phases

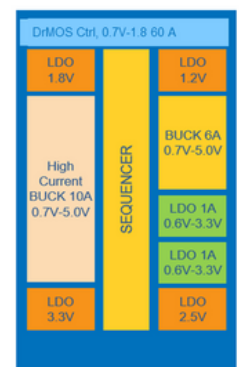
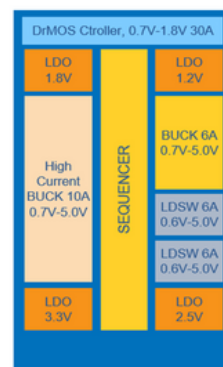
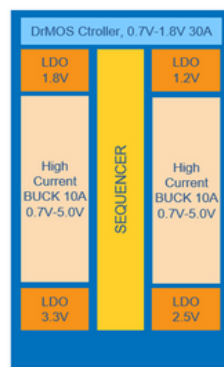
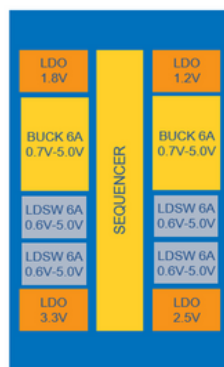
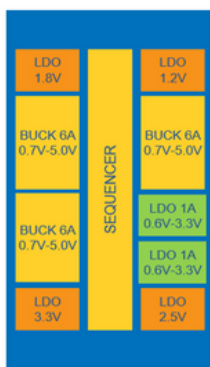
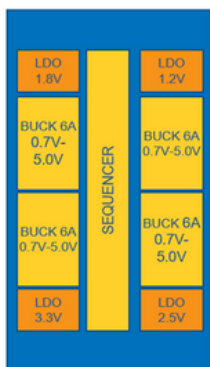

one AmP chip can be configured into
more than 300+ combinations

AnDAPT

PROGRAMMABLE POWER

find out more on andapt.com